

Advanced • TV™ 7 Series

AT7350-1 ATSC DIGITAL TRANSMITTER



OFFERING INDUSTRY-LEADING BROADCAST SOLUTIONS—EMPOWERING BROADCASTERS TO DO MORE WITH LESS.



FAST FORWARD TO DIGITAL WITH LINEAR PERFORMANCE

LINEAR has a complete range of cost-effective, high performance flash-cut exciter and transmitter solutions to get you on the air fast—or allow you to upgrade a current digital operation.

LINEAR hardware and software provides best-in-class performance. Proprietary digital pre-correction algorithms for non-linearity and equalization on passive components set us apart from the competition—along with our low cost of entry into the digital world.

LINEAR is a leading manufacturer of digital exciters and transmitters with state-of-the-art designs and world-class quality manufacturing.

Not just digital. Better digital.™

Contact us today for more information.

AT7350-1 ATSC DIGITAL TRANSMITTER

FEATURES

- ▲ 350 W RF Output
- ▲ Automatic "one-click" linear and non linear pre-correction
- ▲ Fully Solid State
- ▲ Modular Construction
- ▲ Individual Air Cooled Drawers
- ▲ SNMP Interface and PC Configurable
- ▲ Soft-start and Power Factor Correction
- ▲ Fully Self protected LDMOS Technology

APPLICATIONS

- ▲ LPTV Transmitter
- ▲ LTPV Translator (External Receiver / Decoder Required)

OPTIONS

- ▲ Translator option (Receiver/Decoder)
- ▲ AT7001-1 options 3, 4, 5, and 6
- ▲ Spares Kit
- ▲ Set of Wheels (Total height with wheels 43")

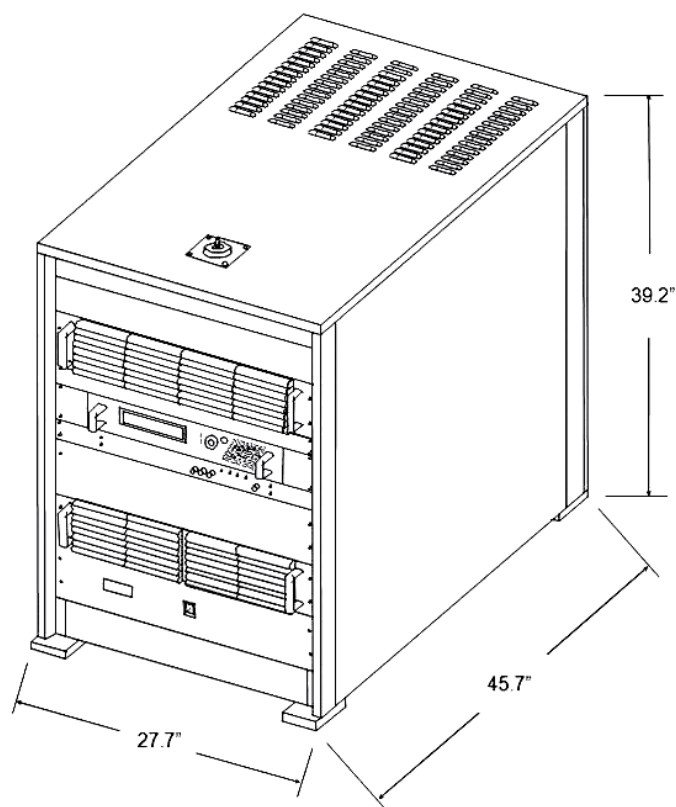

TECHNICAL SPECIFICATIONS

TRANSMITTER TYPE NUMBER	AT7350-1
Transmitter/Translator Power Output (W)	350
Transmitter / Translator Size (W x D x H - Inches)	27.7"x45.7"x39.2"
Number of PA's	1
RF Connector Type	7/8" Flanged
Transmitter / Translator Weight (lbs)	418
Heat Load of each Transmitter/ Translator (BTU)	5,900
Air Flow (CFM)	540
Power Consumption (Maximum)	2690
Operation AC Voltage (Volts) / Frequency (Hz)	208 / 60

GENERAL

Serial Interface	RS 232
Oscillator	Synth by PLL
Internal Time base	10 MHz OCOX
Frequency Stability (including Power Factor Correction)	+/- 0.3 ppm
Ideal Room Temperature Range (degrees F)	40 to 90
Ideal Room Humidity Levels	0 - 80%

INPUTS

Transport Stream Input Compliant to ATSC/MPEG2 SMPTE 310	YES
Transport Stream Input - ASI	YES
Transport Stream Connector	75 Ohm BNC
Transport Stream Datarate - SMPTE 310	19.39 Mbps
Transport Stream Datarate - ASI	270 Mbps
External Time Base	10 MHz (0-10dBm)
External Time Base connector	50 Ohm BNC

OUTPUTS

Frequency Range	UHF Ch 14-69
Pilot Frequency Overall Stability	+/-0.3 ppm
Peak-to-peak Amplitude Frequency Response	<0.15 dB
Peak-to-peak Group Delay	<15 nS
Phase Noise @20kHz Offset	<-104 dBc/Hz
Modulation Error Ratio (MER)	> 38 dB (EQ. ON)
Output Sample Connector	N Type
Frequency Adjustment Steps	1 Hz
Symbol Rate	10.76 MHz
Digital to Analog Converter	16 bit
Test Signal - PRBS Pseudo Random Bit Sequence	YES



Linear Industries, Inc. 2531 Technology Dr., Suite 310 ▲ Elgin, IL 60124, USA ▲ 1.847.428.5793 ▲ www.linear-tv.com